

OTTO ENVIRONMENTAL SYSTEMS  
Urban Furnishing



UWS  
*underground  
waste system*



# underground waste system

## *quality of life*

---

1

- Opening of disposal bin at optimum height
- Minimised malodour
- Less noise disturbance from glass disposal
- Pleasing design
- More room for pedestrians
- Unobtrusive positioning

## *flexibility*

---

2

- Improved residential neighbourhood thanks to upgraded street image
- Modular design: front, "archiplate" and base plate are individually adjustable
- Allows scope for town planners' and architects' planning concepts
- Psychological threshold against illicit dumping of refuse

## *efficiency*

---

3

- Cost reduction through change to bring system
- Compatible with existing logistic's systems
- One man operation waste collection
- Optimum content level of containers
- Low maintenance
- Efficient route planning with optional identification system
- Minimised risk of fire from paper and textiles
- Reliable functioning thanks to mature technology
- Anti-corrosive galvanised finish

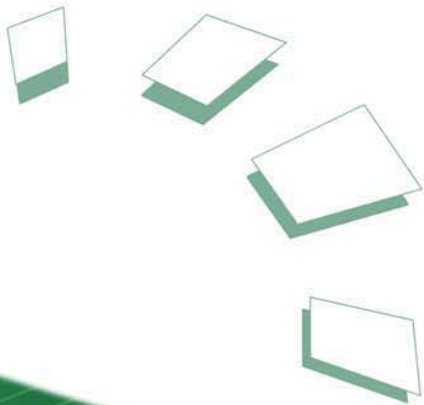

# UWS Principle

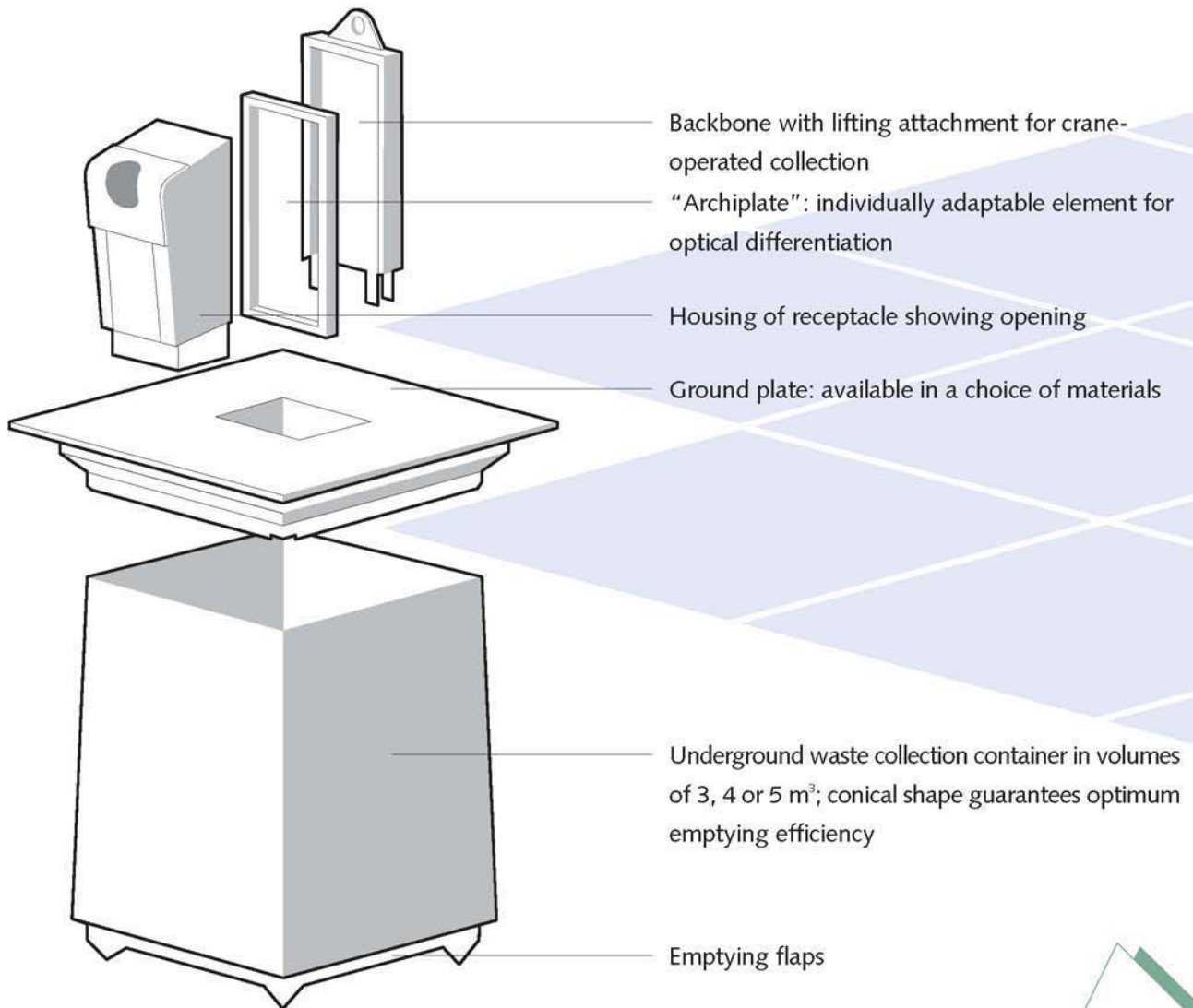

*UWS is more than just a refuse bin. The system is a modular solution for flexible, efficient disposal of waste in public or community areas.*

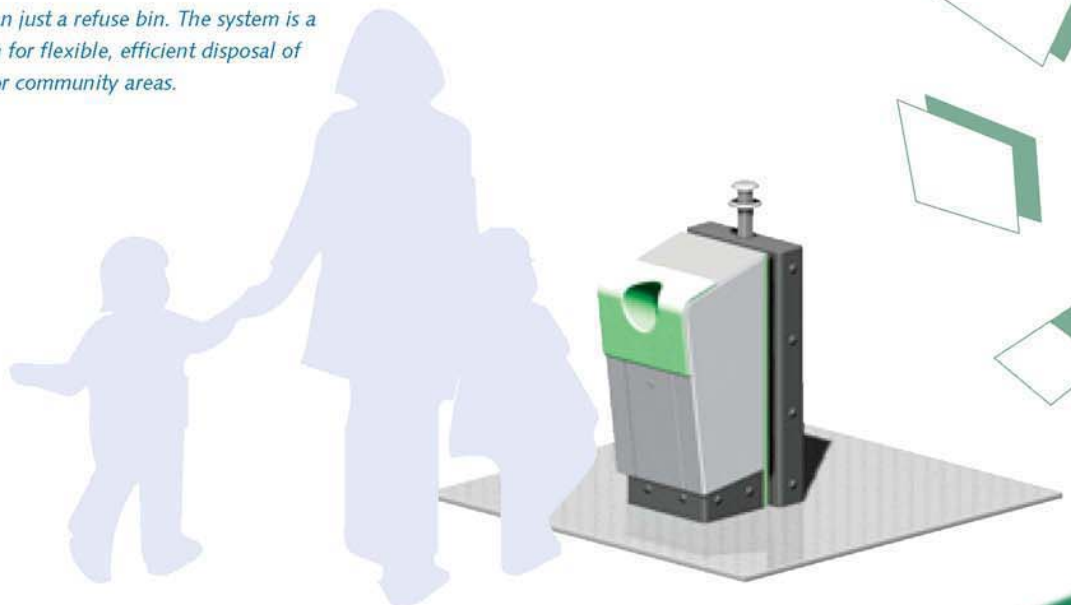

# modular & flexible unlimited possibilities

## *archiplate & backbone*

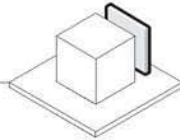

- Innovative modular concept: bin divided into backbone and receptacle module: configurable & flexible
- Archiplate can be adapted to surroundings in terms of colour, shape and material
- Easily integrated into public image
- Stylish appearance due to possible combination of materials
- Scope for incorporating additional functions
- Backbone easily accessible for maintenance

## *housing*

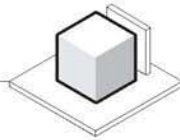

- Dividing the container into housing and backbone allows the receptacle to be adapted more easily to specific requirements
- Project-related housing designs are facilitated
- Inspection flap for checking content level
- Designed by Bas Pruysen
- Large choice of colours and lacquer effects

## *base plate*

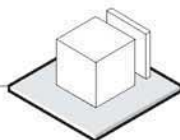

- Easy to integrate into ground surface
- Plenty of scope for different materials and designs, ranging from stone and metal up to granulated, recycled rubber

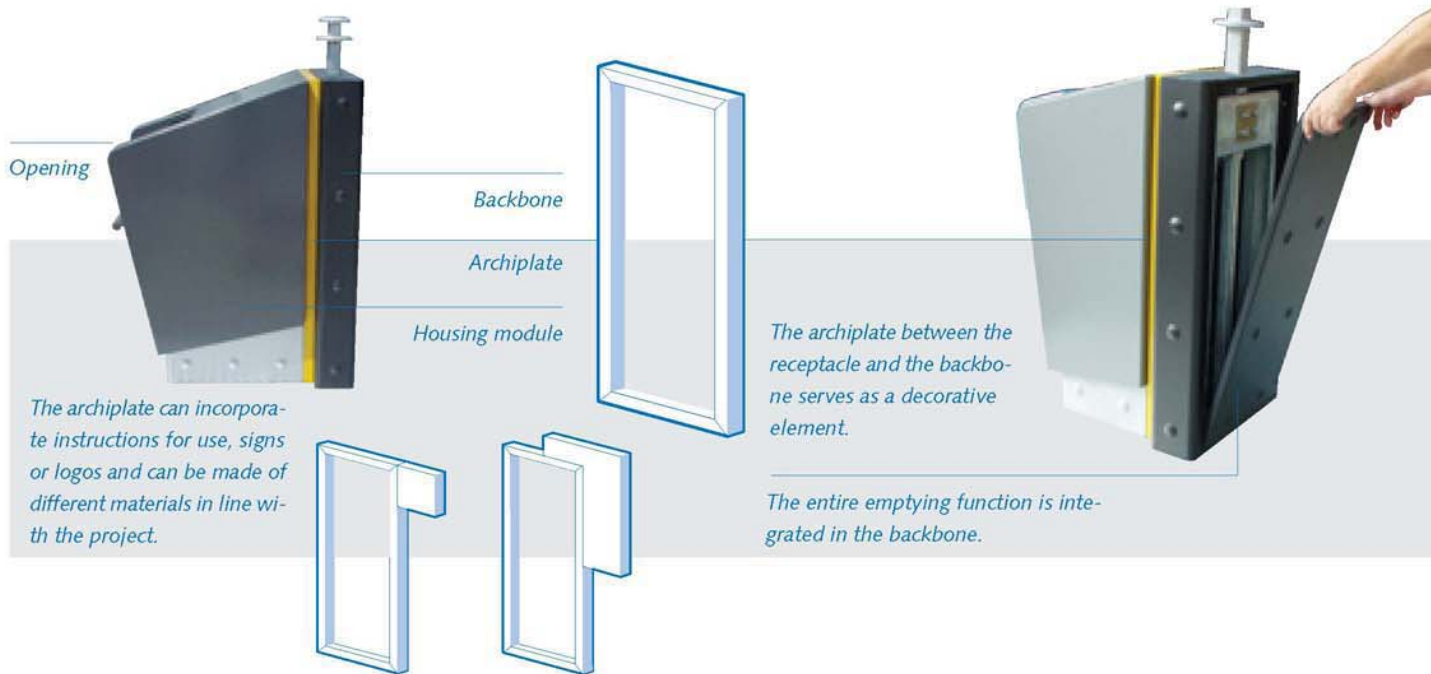

Housing with opening for glass



Housing with opening for paper and packaging



Housing with opening for waste with limited volume

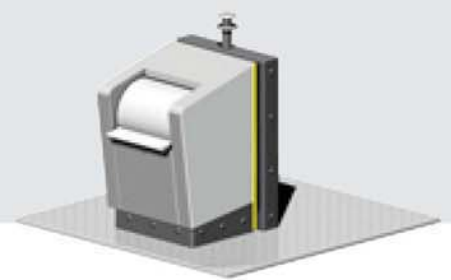

Paved ground surface



Rubber ground surface



Metal ground surface



# safe & perfected the fourth generation



*Lifting, emptying and locking are controlled via a central, integrated mechanism*

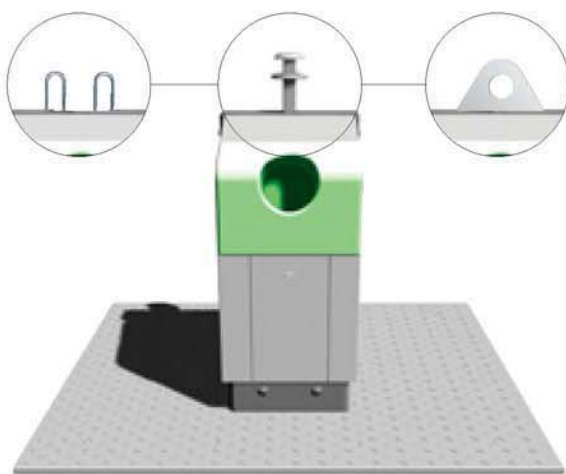

*All the standard hoisting systems available on the market can be supplied.*

## **MORE THAN 10.000 UNITS INSTALLED**

UWS has already been successfully installed in several European countries. The large number of projects that have been realised so far serves as a basis for a mature product that provides the greatest possible safety to meet your requirements. The Otto system represents the fourth generation of underground waste containers and so reflects the outcome of years of experience.

## **ASSEMBLY**

Prefabricated industrial construction parts and precise assembly instructions allow for a process-optimised installation.

## **USAGE**

The Otto system can be used for all standard kinds of refuse:

- Paper
- Glass or PET bottles
- Organic waste
- Domestic waste
- Textiles
- Plastics and others

## **EMPTYING**

- Optional electronic system control and monitoring.

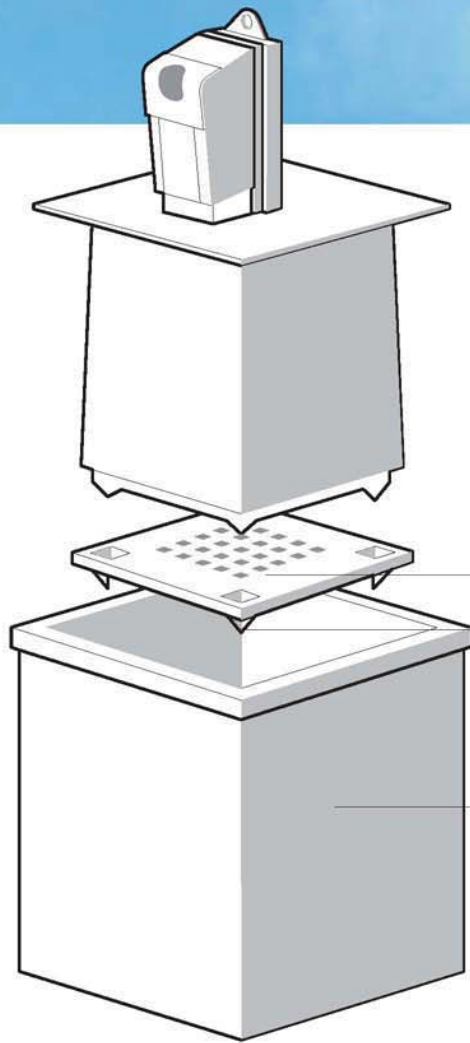

Safety base plate with counterweights, which protects the hollow cavity during the emptying operation

Centring system for safe positioning

Waterproof, reinforced concrete housing for underground waste container



*The self-closing drum of the receptacle module provides ideal accident protection. The adaptable drum size makes the system suitable for accepting different sack volumes. The ergonomic design of the housing facilitates placing items in the drum.*

## SERVICE

Our experienced team offers you counselling and support in the choice of the most suitable solution. We shall accompany you through all phases of the project and provide you with a comprehensive, clearly laid out documentation.

*The modular concept with its segregation into usage area and mechanical area simplifies installation and service. The maintenance flap in the lower front section allows for easy access to the input chute. It takes just a few manual operations to make the mechanical module accessible as well.*



# OTTO ENVIRONMENTAL SYSTEMS

Urban Furnishing

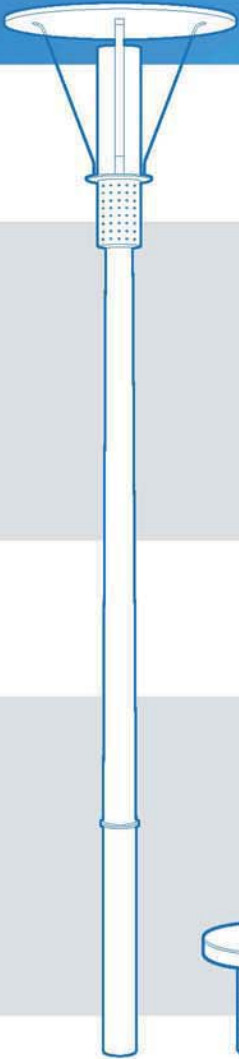

## INFORMATION & CONSULTATION

We are at your disposal - providing assistance at all planning stages, from the concept to the installation and maintenance.

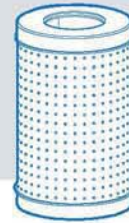
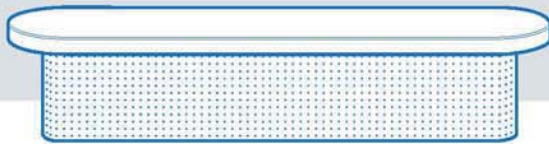
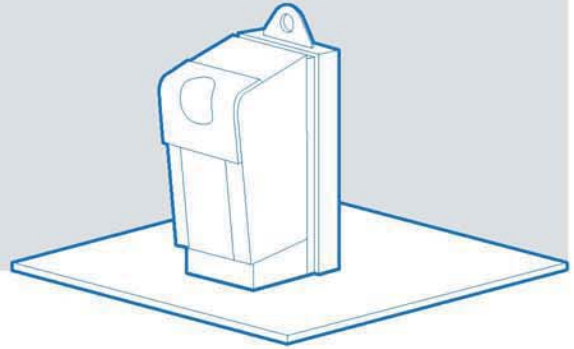

Our competence:

### COUNSELLING

Concepts for individual solutions

### DEVELOPMENT

Designing of optimum receptacles

### PRODUCTION

Manufacturing at our own plants

### DISTRIBUTION

Direct sales route to customer

### SERVICE

Logistics, container management, maintenance

## THE OTTO RANGE

The extensive range of metal or plastic receptacles for installing on the ground or suspending on posts for community areas is ideal for combining with the UWS system. We also supply the matching supports, benches and lampposts, covering a broad spectrum. Allow us to submit proposals aligned to your specific requirements.

